

Bacterial Transformation

3.3 Teacher's and technician's notes

REVISED VERSION

Transformation: a clue to life's mystery

Natural transformation of bacteria was first described by the British microbiologist Fred Griffith in 1928. He showed that one strain of *Streptococcus* (then known as *Pneumococcus*) could be converted into another by an unknown, non-living material. The nature of Griffiths's 'transforming principle' remained a mystery for the next 15 years.

Oswald Avery and his colleagues in the USA carried out meticulous experiments for more than a decade to reveal the identity of the mystery material. Unfortunately, even though their findings (published in 1944) look conclusive to a modern observer, many scientists at the time argued against the Avery team's conclusion that DNA was the molecule of inheritance. Its molecular structure was thought to be too simple to carry the genetic message.

It was not until 1952 — just a year before the publication

of Watson and Crick's famous 'double helix' letter to *Nature* — that the majority of scientists were convinced that DNA was the primary genetic material. It was then that Alfred Hershey and Martha Chase showed, using radiolabelled DNA and protein, that the infective component of a bacteriophage was nucleic acid, and not the structurally more complex protein.

By the mid-1970s, transformation, which had provided a vital clue to the molecular nature of the gene, had become a key tool for the genetic modification of living things.

Genetic modification is central to many developments in modern biotechnology, and has been largely responsible for its evolution from a craft-based industry allied to brewing and baking to a major influence on human health and agricultural production in this millennium.

Educational context

Educational aims

The concepts and skills involved in performing the practical procedure make it simple enough for 14–16 year-old students, and with appropriate additional tasks it can be made sufficiently challenging for post-16 students.

This practical procedure introduces several important ideas and provides:

- a safe practical demonstration that DNA is the genetic material;
- practical experience of one of the key techniques used in genetic modification;
- an opportunity to learn, understand and carry out basic microbiological techniques;
- a concrete context for discussion of some of the ethical, social and safety issues associated with genetic modification;
- an opportunity for more able and Post-16 students to plan and carry out (necessarily limited) open-ended practical investigations (see page 17).

The practical task

Students transform a laboratory strain of *Escherichia coli* with plasmid DNA. The plasmid contains a gene encoding a green fluorescent protein (GFP) from the jellyfish *Aequorea victoria*. GFP glows brightly when illuminated with ultraviolet light, so it acts as a 'reporter' to confirm that the bacteria have indeed been transformed.

Transformation is a relatively inefficient process, and only a small proportion of the *E. coli* cells take up plasmid DNA. An antibiotic is therefore needed in the agar medium to prevent the growth of untransformed bacteria which would, if they were able to grow, outnumber the transformed cells. The transformed cells can grow in the presence of the antibiotic, because a second gene on the introduced plasmid confers on its hosts resistance to the antibiotic.

Also on the plasmid is an origin of replication that allows the plasmid to be duplicated within the cells and a control region that 'switches on' the GFP gene. The switch is triggered by a chemical called IPTG, so in addition to the antibiotic, IPTG is incorporated into the agar medium.

'Controls'

Normally, when undertaking a bacterial transformation such as this, one would carry out several 'control' treatments. These would include, for example, a 'transformation' without plasmid DNA, plates without antibiotic and plates without the inducer, IPTG. Several plates and types of agar media would be needed to perform all of these tests, adding considerably to the preparation time required and to the cost of carrying out the work.

The educational benefit of such tests is minimal, particularly if the 'controls' are simply presented to students as part of a predetermined procedure that requires little thought on their part. There is greater value in asking students to consider appropriate controls themselves (see the student worksheet on page 19).

Equipment and materials

Each student or working group needs:

Straight from the kit

- a copy of the Student's guide [1]
- a sterile single use 1 mL pipette
- a sterile single use spreader
- a sterile single use 5 μ L inoculation loop
- access to a UV LED torch (in the following lesson)

Prepared in advance by the teacher or technician

(see pages 4, 5 and 6 of this guide for instructions)

- stock cultures of *E. coli*, K-12 strain DH10B, **prepared no more than 48 hours in advance** (to be shared by class)
- ~200 μ L of plasmid DNA in transformation buffer, dispensed into a green microcentrifuge tube on ice.
- a Petri dish containing LB agar, kanamycin and IPTG.

Not in the kit: supplied by you

- a small cup of crushed ice [2]
- 500 mL or 1 L container of freshly-diluted *Virkon*[®] disinfectant (for disposal of contaminated waste)
- a permanent marker pen
- adhesive tape for sealing the Petri dishes
- access to an incubator set at 37 $^{\circ}$ C [3]
- a Bunsen burner

Notes

1. Supporting PowerPoint and Keynote presentations can also be downloaded from the NCBE's web site: www.ncbe.reading.ac.uk
2. Obtain ice cubes from a supermarket, wrap them in several thick plastic bags and smash the ice up with a hammer.
3. CLEAPSS and SSERC (the school safety organisations in the United Kingdom) advise that where necessary, incubation at 37 $^{\circ}$ C is permitted, provided that good microbiology laboratory practice is followed (see pages 14–16).

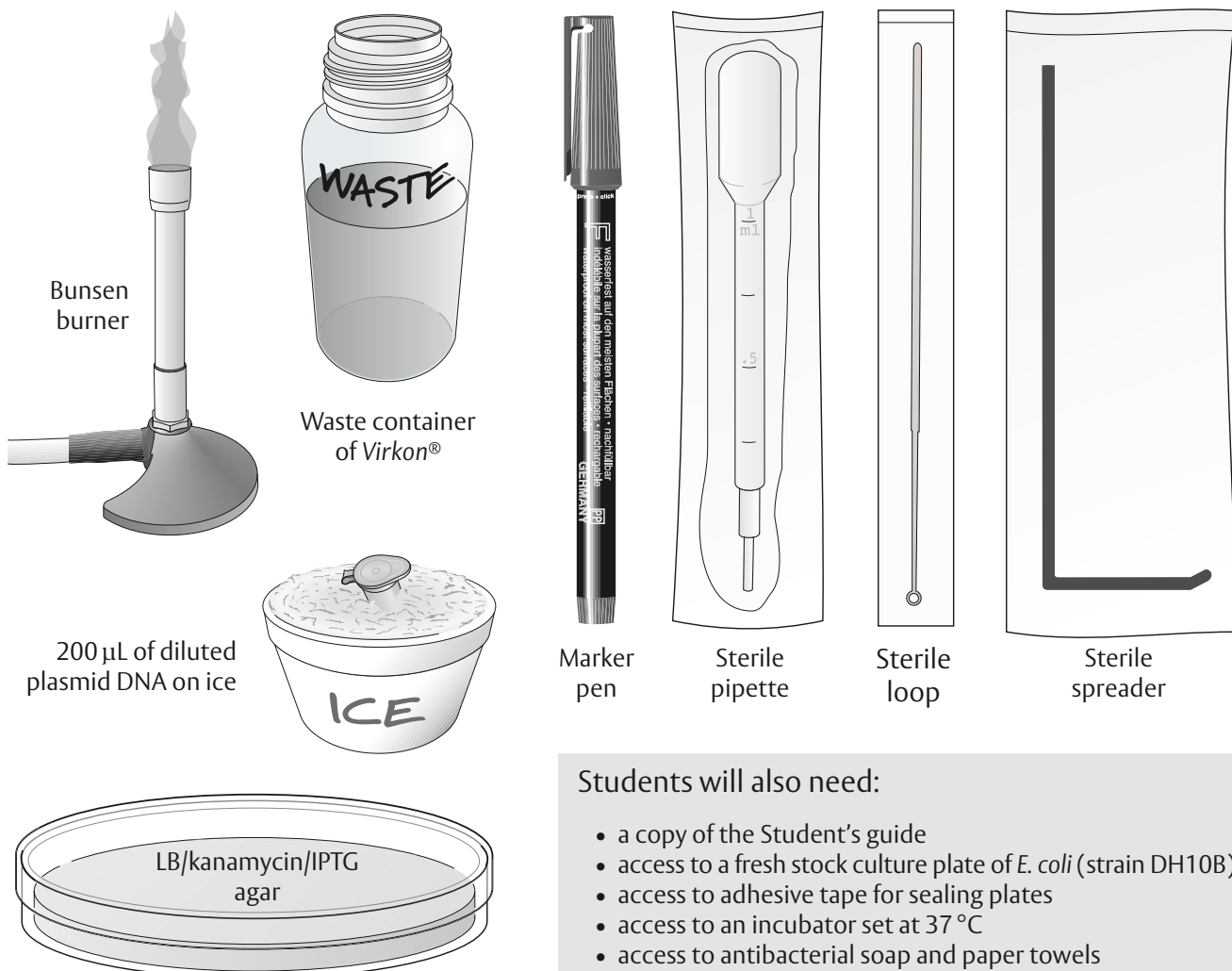

Students will also need:

- a copy of the Student's guide
- access to a fresh stock culture plate of *E. coli* (strain DH10B)
- access to adhesive tape for sealing plates
- access to an incubator set at 37 $^{\circ}$ C
- access to antibacterial soap and paper towels

Preparing the materials for students

Plasmid DNA and transformation buffer

We have provided two tubes of concentrated plasmid DNA solution and two tubes of transformation buffer. This is so that, should you wish, you can use half of the material for one class and half for another class at a later date.

1. On the day of the experiment, the plasmid DNA required (one tube for 9 groups) needs to be thoroughly defrosted and the tube should be firmly tapped on the bench to ensure all of the liquid returns to the bottom of the tube.
2. The plasmid DNA can then be transferred into one of the transformation buffer tubes using the sterile mini Pasteur pipette. Make sure all of the DNA is taken into the mini pipette and that the entire volume is dispensed into the transformation buffer tube and mixed well. The plasmid DNA solution can now be dispensed into tubes for the students to use.
3. Each group will need ~200 μl of the plasmid DNA solution. For your convenience, we have provided a foam block for holding the tubes while you do this. Use a sterile 1ml pipette from the kit to dispense the diluted plasmid solution into each of the green microcentrifuge tubes. Each drop of liquid from one of these pipettes is 33 μl , so dispense six drops (198 μl) into each tube. *Practical hint: you may find it easier to dispense the liquid accurately if you squeeze the stem of the pipette, not the bulb.*
4. Close the tubes firmly after dispensing the liquid and tap each tube firmly on the bench to ensure all the liquid lies at the bottom of the tube.

IMPORTANT
Before dispensing, tap the tube(s) on the bench to ensure that all of the liquid is returned to the bottom of the tube(s).

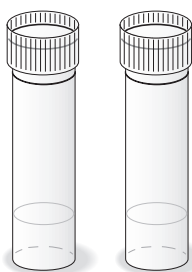

Plasmid DNA, diluted in transformation buffer

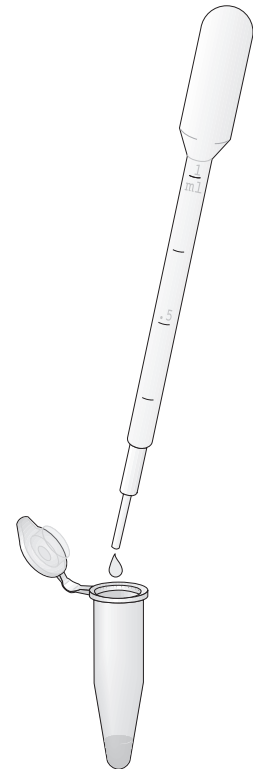
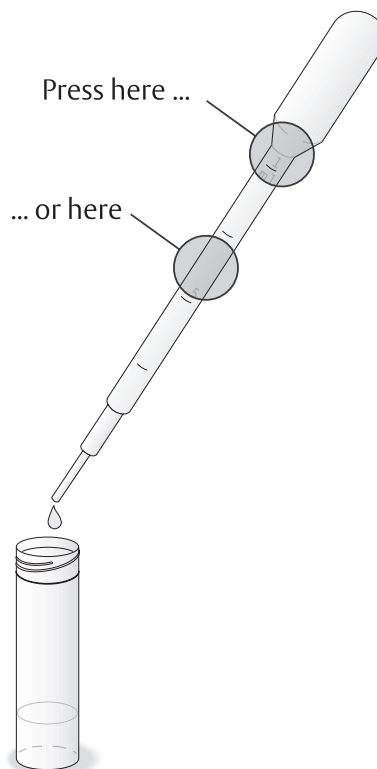

Dispense six drops into each tube, then cap and freeze until needed

Growth media

This kit contains two sorts of agar growth media: LB agar without added antibiotic and LB agar with kanamycin. These must be prepared in a **microwave**. They *must not* be prepared by autoclaving as this would destroy the kanamycin in the medium. **IMPORTANT: Used plates must be disposed of in the normal way by autoclaving them.**

Each sachet contains enough media for 200 mL of agar medium. The instructions below should be followed carefully.

NOTE: The IPTG is stored in the freezer, this needs to be defrosted so you can add it before pouring the plates (see point 5 opposite)

Preparation of the sterile growth media

You will need:

- a microwave oven
 - heat-proof gloves
 - 2 x 500 mL borosilicate glass flasks, beakers or bottles
 - 1 x 1 L borosilicate glass flask or bottle
 - plastic film to cover the glass containers
 - 400 mL of distilled or deionised water
 - a water bath at 50 °C
1. Take the sachet labelled 'LB agar base'. Empty the contents into a clean 500 mL borosilicate glass bottle, flask or beaker.
 2. Add 200 mL of deionised or distilled water. *If you are using a beaker, cover it with plastic film, punctured once or twice.*
 3. Heat the liquid in a microwave oven on a MEDIUM power setting until bubbles start to appear (about 2–3 minutes). **IMPORTANT: You must watch the liquid constantly as it is heating to ensure that it does not boil over.**
 4. While wearing heat-proof gloves, take the container from the oven and swirl the liquid gently to mix. **CAUTION: Any solution heated in a microwave oven may become superheated and boil vigorously and suddenly when moved or touched. Take extreme care when handling the containers and ensure that you wear heat-proof gloves.**
 5. Reheat the liquid for 30 seconds at MEDIUM power and swirl gently as before. Do not overboil.
 6. Repeat step 5 if necessary until the powder is completely dissolved (the liquid should be clear, not turbid).
 7. Repeat steps 1–6 with the sachet of LB/ Kanamycin
 8. You should now have two containers of liquid media, which should be covered with clean plastic film or foil. Let the media cool to 50 °C (until the containers can be held comfortably in your hands).
 9. The media must be kept molten in a water bath at 50 °C until you are ready to pour the plates. **Remember to label the two flasks in some way so that you can tell them apart.**
 10. While the agar medium is cooling, prepare the Petri dishes for pouring. **Do not pour the plates if the medium is hotter than 50 °C, as this will result in excessive condensation.**

Preparation of the agar plates

Each student or working group will require one Petri dish containing 12–15 mL of sterile kanamycin-containing agar.

In addition, you will need to prepare two plates of plain LB agar (without kanamycin) on which to grow cultures of untransformed bacteria that can be used as a source of bacteria by the class.

1. Open the bag of sterile Petri dishes. Cut the end of the plastic bag carefully so that it can be re-used to store the poured plates. Spread the Petri dishes out on the bench, unopened, ready to pour the agar.
2. Swirl the **LB agar** flask carefully to mix the agar. (When the mixture was prepared, the agar may have sunk to the bottom of the flask.)
3. When the agar has cooled to 50 °C, lift the lid of a Petri dish just enough to pour in some agar. Do not put the Petri dish lid down on the bench. Quickly add enough liquid to cover the bottom of the plate (you will need between 12 and 15 mL per Petri dish). Replace the lid immediately and tilt the plate to spread the agar.
4. Pour a second plate in the same way. Label both plates so that you know that they contain plain LB agar. *Note: If you wish to have a few more stock plates of plain LB agar for class you would need to provide your own LB agar and Petri dishes.*
5. Now mix the remaining LB agar with the **kanamycin-containing agar** in a larger, clean container. Add all of the IPTG provided in the screw top tube to the LB agar you have just diluted. Use the 1 mL pipette provided to do this. Swirl the container to mix the contents. The IPTG is needed to switch the GFP gene on so that the transformed bacteria appear fluorescent green under UV light.
6. Continue pouring the rest of the plates, using this mixture. Flame the mouth of the flask or bottle occasionally to maintain sterility.
7. If necessary, remove bubbles from the surface of the poured agar plates by briefly touching the surface with a Bunsen burner flame while the agar is still molten.
8. Allow the agar to solidify, undisturbed (this takes about 15 minutes).
9. Mark the plates so that you know they contain kanamycin. *Hint: an easy way to do this is to stack the plates, then to run a felt pen down the side of the stack, marking the edge of each Petri dish.*
10. Stack the plates, with the medium uppermost, in the original plastic sleeve for storage.
11. Surplus media may be used to produce extra plates or disposed of. **IMPORTANT: unused media MUST be autoclaved before disposal, to destroy the kanamycin it contains.**

Ideally, Petri dishes of agar should be poured *at least* 24 hours before the practical session, so that any contamination can be identified and to allow the agar to dry sufficiently. Plates that are contaminated **MUST NOT** be used. They should be disposed of by autoclaving.

Plates may be stored, inverted, (agar uppermost) for up to two weeks in a fridge at 3–5 °C.

IMPORTANT: Plates should be removed from the fridge a few hours before the practical session, to allow any condensation in the Petri dishes to evaporate.

Preparation and maintenance of the *E. coli* culture

The kit includes a slope culture of *Escherichia coli* DH10B. This is the ONLY culture that should be used for this practical investigation. DH10B should be grown on LB agar as this contains all the nutrients the bacteria need.

Storage of the culture

Microbial slope cultures should generally be stored at *room temperature*, in the dark. They can be kept like this for up to 12 weeks, after which the bacteria should be subcultured onto a new slope of LB agar to ensure that you maintain a culture of viable cells. Slope cultures should NOT be stored in a fridge.

Streaking out

When you receive the culture, it is good practice to streak it onto a plate, progressively diluting the cells by spreading them out so that there are individual colonies on part of the plate. Stock plates should be prepared by taking cells from these colonies.

There are two common patterns for streaking plates: these are shown in the diagrams below. The (wire) loop should be flamed then allowed to cool between each set of streaks.

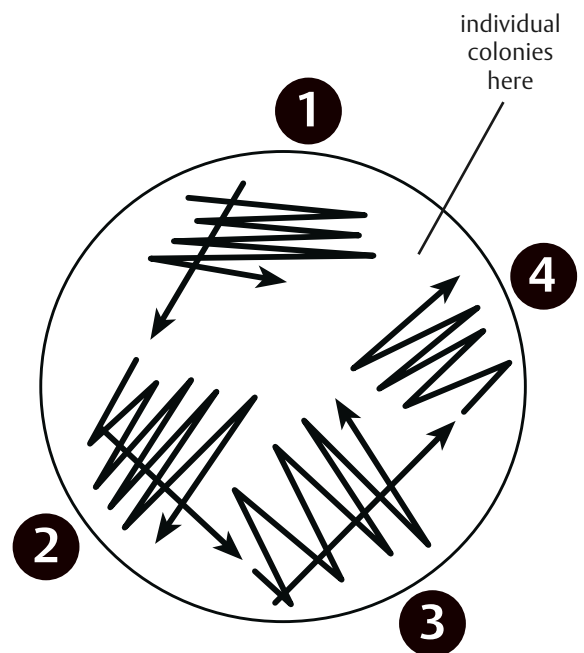
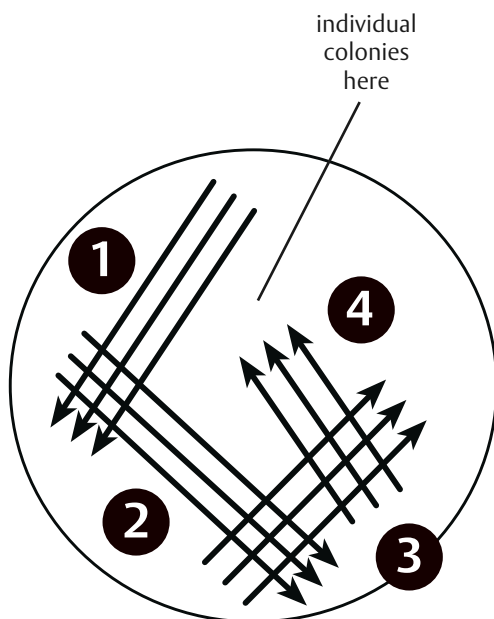

Above: Two patterns which are often used when streaking out bacteria on plates.

Prepare the plates one or two days in advance

Fresh stock cultures should be prepared from the slope for students to use by streaking the bacteria onto plates. Once you have prepared these plates they should ideally be used *within 48 hours*. To achieve good results, it is essential that students scrape a reasonable mass of cells from the stock plate, taking care not to scrape any agar from the plate.

[If you keep the cultures for five days, you will still obtain results, but there will be far fewer transformed cells. If you keep the plates for a week, you *may* still obtain transformed cells, but typically there will be only three or four transformed colonies per plate.]

Subculturing for storage

Normally, you would subculture bacteria from a slope every eight to twelve weeks. In this way, you can usually maintain bacterial cultures for many months.

The strains used for genetic modification are often enfeebled, however, (e.g., lacking the enzymes needed for DNA repair if they are exposed to ultraviolet light). There is a risk that, after repeated sub-culturing, strains may accumulate undesirable mutations that will affect the success of the practical procedure. Unless you have the facilities for maintaining stock cultures at -80°C , it is better to obtain a fresh slope culture of DH10B when you wish to carry out this practical work.

Antibiotic resistance

The need for a selectable marker gene

The transformation process is very inefficient and only a small proportion of the bacteria treated will take up the novel plasmid. A means of selecting those cells that have been transformed is therefore needed.

Consequently, a gene is included on the plasmid which confers resistance to the antibiotic kanamycin, so that when kanamycin is included in the agar medium, only those bacterial cells that carry the plasmid will grow.

Resistance concerns

Resistance to the effects of many antibiotics is now widespread in several species of disease-causing microbes. It is important to appreciate how such resistance is transferred and selected for, and the special steps that have been taken in this particular kit to ensure that we do not contribute to this increasingly serious problem.

Resistance genes have evolved to give the bacteria that possess them the ability to thrive in environments containing antibiotics secreted by other microorganisms. Usually these genes encode enzymes that inactivate specific antibiotics or prevent them from working in some way. The widespread and often indiscriminate use of antibiotics in the treatment of disease has favoured resistant organisms, as the bacteria that are susceptible are simply killed off.

Natural transfer

Resistance genes are often carried on plasmids, which can pass from one bacterial cell to another of the same or a related species by a natural 'mating' process called conjugation. During conjugation, a tube or pilus is formed between adjacent cells, through which the plasmid passes.

The genes required for the formation of the pilus are also carried on a plasmid (an 'F' or fertility plasmid). The host strain provided in this kit (DH10B) has an F plasmid, but this has been deliberately disabled so that no pilus is formed and consequently plasmids cannot transfer between cells.

Missing genes

For a plasmid to travel through a pilus, two additional requirements must be met. The plasmid must possess a gene encoding a mobility protein (*mob*) and have a *nic* site.

The mobility protein nicks the plasmid at the *nic* site, attaches to it there and conducts the plasmid through the pilus. The plasmid used in the transformation (*pNCBE-kan-GFP*) has neither a *nic* site nor the *mob* gene.

This ensures that once it has been introduced into a bacterial cell by artificial means (transformation) the novel plasmid cannot transfer into other bacterial cells.

As a further precaution, the plasmid DNA is non-methylated. That is, it is not protected from naturally-occurring restriction enzymes by methyl ($-CH_3$) groups. Therefore it would be degraded by restriction enzymes if it was to enter a wild-type bacterial cell.

The host strain DH10B is deliberately enfeebled, and has been selected for its non-pathogenic nature, its inability to survive outside the laboratory or to colonise the mammalian gut. It has several features that have been deliberately introduced into the genome of the bacterium to further assure biological safety (see *Bacterial strains and their genes*, pages 9–11 of this guide).

Physical containment

In addition to the numerous biological containment measures described above, the kit protocol requires that good microbiology laboratory practice is followed to ensure that the microorganisms are physically contained during the investigation and destroyed afterwards. Good microbiology laboratory practice is described on pages 14–16 of this document.

These methods of physical and biological containment have been adopted to make this educational protocol as safe as possible.

How kanamycin kills bacteria

Kanamycin kills bacteria by stopping protein synthesis in their cells. It does this by binding irreversibly to the 30S subunit of the bacterial ribosomes (eukaryote ribosomes have a different structure, so humans *etc.* are not affected). The kanamycin/ribosome complex initiates protein synthesis by binding to mRNA and the first tRNA. However, the second tRNA cannot bind, and the mRNA/ribosome complex dissociates.

Unlike several other antibiotics (*e.g.*, ampicillin) kanamycin kills all cells, rather than just those that are actively growing. Bacteria transformed with *pNCBE-kan-GFP* therefore require a short 'recovery period' before they are plated out onto kanamycin-containing plates. This allows the enzyme conferring resistance to be expressed.

How the kanamycin resistance works

Resistance to the effects of kanamycin is provided by the gene *kan^R* on the *pNCBE-kan-GFP* plasmid. This gene encodes an aminoglycoside 3'-phosphotransferase (APH).

APH catalyses the transfer of a phosphate group from ATP to a hydroxyl group of kanamycin. The phosphorylated antibiotic is unable to bind to the bacterial ribosome, so the antibiotic is inactivated. APH is relatively unstable, and is inactivated readily by increased temperatures or pH

changes. Its requirement for ATP means that this enzyme can only function in environments where that compound is abundant (e.g., inside cells) [For more information, see: www.rcsb.org/pdb/101/motm.do?momID=146]

Why use kanamycin?

While it would be easier to use a resistance marker that did not require a recovery period, there are several compelling reasons for using kanamycin and kanamycin resistance:

- unlike ampicillin and many other antibiotics, kanamycin is very seldom used to treat human disease, having been superseded by other drugs;
- it is needed in small amounts in culture plates (about a quarter of the concentration normally used for ampicillin);
- unlike ampicillin, kanamycin is not absorbed by the gut (in clinical use, it has to be injected). Therefore the safety hazard posed by accidental ingestion is reduced;
- kanamycin is relatively stable, so that plates containing it can be conveniently prepared well before a lesson;
- ampicillin resistance genes (β -lactamases) often confer resistance to other related antibiotics whereas the *kan^R*

gene affects a lesser range of antibiotics of limited therapeutic use;

- for several reasons, the use of kanamycin resistance markers is now widely accepted as safe, whereas scientists disagree about the wisdom of using ampicillin resistance markers.

In fact, the antibiotic resistance marker that is incorporated into *pNCBE-kan-GFP* might be better described as a kanamycin *tolerance* marker, as it does not confer full resistance to kanamycin to bacteria that possess it.

As stated above, the *kan^R* gene encodes an enzyme that modifies kanamycin, preventing it from working. This enzyme does not, however, alter all of the kanamycin in the medium, so high doses of kanamycin will prevent the growth even of the transformed bacteria. This is the reason that the LB/kanamycin/IPTG agar medium has to be 'diluted' with plain LB agar before use, to reduce the kanamycin concentration.

It is important, however, that all media that contain kanamycin are autoclaved before disposal to destroy the antibiotic, whether or not the media has been used to grow bacteria.

Further information

General reading

A glow in the dark by Vincent Pieribone and David F. Gruber (2005) The Belknap Press of Harvard University Press. ISBN: 978 0 674 02413 7. *Authoritative and beautifully-illustrated small book on the discovery and application of GFP.*

Glowing genes: A revolution in biotechnology by Mark Zimmer (2005) Prometheus Books. ISBN: 978 1591022534. *Popular but slightly error-prone account of the discovery and use of GFP.*

The transforming principle. Discovering that genes are made of DNA by Maclyn McCarty (1986) W. W. Norton and Company. ISBN: 978 0393304503. *Biographical account of the work of Avery, McCleod and McCarty by one of the participants.*

Web sites

In 2008, the Nobel Prize in Chemistry was awarded to Osamu Shimomura, Martin Chalfie and Roger Tsien for the discovery and development of GFP. More information can be found at the Nobel Prize web site: www.nobelprize.org/nobel_prizes/chemistry/laureates/2008/

Information about GFP and a template for a paper model can be obtained from the Protein Data Bank: www.rcsb.org/pdb/101/static101.do?p=education_discussion/educational_resources/GFP_activity.html

Bristol University produces a similar series which features an article on GFP written by Timothy King and Paul May: www.chm.bris.ac.uk/motm/GFP/GFP.htm

Molecular structure data

The computer-generated image on the cover of this booklet and in the *Student's guide* were created using structural data from the *Protein Data Bank*: www.rcsb.org/pdb

The image shows a computer model of a molecule of green fluorescent protein, using data from: Ormo, M., *et al* (1996) Crystal structure of the *Aequorea victoria* green fluorescent protein *Science* **273**, 1392–1395 [Protein Data Bank ID: 1EMA].

The software used to produce this image was *UCSF Chimera*, which can be obtained free-of-charge from: www.cgl.ucsf.edu/chimera/.

Genetic modification and microbiology safety

The Genetically Modified Organisms (Contained Use) Regulations 2014. Guidance on regulations. Health and Safety Executive (2014) The Stationery Office, London. ISBN: 978 07176 6641 6. *This official document, which is aimed principally at research scientists, can be downloaded from the HSE's web site: www.hse.gov.uk/biosafety/gmo/*

Topics in safety (2001) [Third edition] ASE, Hatfield. ISBN: 0 863 57316 9. *Chapter 16 of this publication covers practical work with DNA in schools. An updated (2014) version can be downloaded from the NCBE's web site: www.ncbe.reading.ac.uk/dnasafety*

Bacterial strains and their genes

Strain names

Individual strains of bacteria are designated by serial numbers that are decided by the laboratories that have isolated those strains. These numbers are not italicised. For instance, *Escherichia coli* CSH50 is strain 50 from Cold Spring Harbor Laboratory, a well-known research establishment in the USA.

For this practical investigation, we have supplied a strain of *E. coli* called DH10B. The 'DH' in DH10B indicates that the strain was produced by Douglas Hanahan, who improved many of the methods used for transforming bacteria with plasmids, initially at Cold Spring Harbor Laboratory then later at the University of California in San Francisco.

Bacterial genotypes

The genotype of a bacterial strain is usually given by listing all of the genes that are known to differ from the wild type. This is done using a system proposed by Milislav Demerec and his colleagues in 1966 [1]. The main features of this system are:

- Each genetic locus is designated by a three-letter, lower-case abbreviation or 'symbol', which is written in italics e.g., *pro* is the symbol for the gene determining metabolism of the amino acid proline;
- Different loci are distinguished from one another by adding a capital letter after the symbol e.g., *argA*; *argB*. If the exact locus at which the change (mutation) has occurred is not known, a hyphen is used instead of a capital letter e.g., *ara-*;
- If it is known, the site at which the mutation has occurred is shown by a number after the locus letter e.g., *hisA38*.
- Δ (the Greek symbol delta) indicates that the genes following it have been *deleted*.
- Conversely, a double set of colons, ::, indicates that the genes following it have been *inserted*.

Phenotypic traits are described in words, or by abbreviations that are explained when they are first used. These abbreviations are distinguished typographically from those referring to the genotype e.g., Arg- (non-italic, with an initial upper case letter) is a phenotype, showing that arginine is required, but *argA* is a specific locus at which a mutation has occurred.

Although Demerec's system is broadly adhered to, there are many exceptions to the rules, often deliberate to avoid ambiguity, but sometimes they are a 'hangover' from earlier naming conventions that have been retained.

Escherichia coli DH10B

In the late 1970s, when the techniques of genetic modification were being pioneered, it was realised that it would be desirable, for safety and other practical reasons, to have specially-developed bacterial strains for laboratory use. DH10B was one of the early strains, produced before the modern era of molecular biology. It originates from an *E. coli* K-12 strain, MG1655.

DH10B has remained popular because it has a high transformation efficiency and can carry large plasmids. It requires growth media that are supplemented with the amino acid leucine (LB agar and broth contain leucine).

DH10B is a K-12 strain. 'K-12' is sometimes wrongly assumed to be a special educational strain of *E. coli* because the acronym 'K-12' is associated with 'Kindergarten-12th Grade' school education in the USA. In this context, however, 'K-12' has nothing to do with schools.

The K-12 strain of *E. coli* was first isolated at Stanford University in 1922. Biochemical and genetic studies by Edward Tatum in the 1940s made the strain popular with researchers and, after many generations of laboratory cultivation, it is now known to have undergone significant changes [2].

These have altered the lipopolysaccharides that compose the outer membrane of the bacterial cell, so that it is a poor coloniser of the mammalian gut (the cells lack three cell wall components: the glycocalyx, liposaccharide core and capsular antigens, that are responsible for recognition and adhesion to gut cells). These changes make K-12 strains particularly safe for laboratory use [3]

Compared to wild type *E. coli*, DH10B would find it difficult to thrive outside the laboratory. For example, although it can grow on glucose, it is unable to use the alternative sugars lactose, galactose or arabinose as an energy source. The entire genome of DH10B was sequenced in 2008 [4]. Compared with the original MG1655 strain, DH10B is now known to have 226 mutated genes.

Genotype of DH10B

The features of this strain that (mostly) differ from the wild type are represented by the following gene symbols:

F-, *mcrA*, Δ (*mrr-hsdRMS-mcrBC*), Φ 80*dlacZ* Δ M15, Δ (*lac*)X74, *recA1*, *relA1*, *endA1*, *deoR+*, *e14-*, Δ (*araA, leu*)7697, *araD139*, *galE15*, *galK16*, *galU+*, *nupG*, *rpsL150* (Str^r), *spoT1*, λ -

Note that this genotype is based on the genome sequence described by Durfee, *et al.* [4] and is slightly different from that which is often stated for *E. coli* DH10B, which pre-dates the sequencing of DH10B's genome.

What the gene symbols mean

F-

This strain lacks the F plasmid which is responsible for pilus formation and conjugation. Therefore plasmids transferred into the bacteria cannot be passed naturally to other cells by conjugation.

mcrA

A mutation preventing the cutting, by restriction enzymes, of DNA that has been methylated at the sequence CmCGG (the m shows that a methyl (-CH₃) group has been added to the first cytosine of the DNA sequence). This permits cloning of DNA from mammals, 'higher' plants and some prokaryotes in the bacterium (DNA from these sources often contains cytosines that are methylated).

Δ (*mrr*-*hsdRMS*-*mcrBC*)

These deletions completely disable DH10B's ability to cut, by restriction enzymes, any introduced DNA.

The *mrr*, *mcrB* and *mcrC* genes perform a similar function to the *mcrA* mutation, in that they prevent the restriction of methylated DNA. The *mcr* and *mrr* deletions therefore permit better cloning of methylated DNA, which is needed for the construction of genomic libraries.

The *hsdRMS* genes encode the restriction enzyme *Eco*KI. This enzyme cuts DNA whose adenines are *not* protected by methyl groups at the enzyme's recognition site. By deleting these genes, as has been done in DH10B, *unmethylated* DNA is also protected from restriction. This makes the strain useful for efficient transformation with unmethylated DNA produced by PCR amplifications, for example.

Φ 80*lacZ* Δ M15

Some of the plasmids that are used for transformation carry a gene (called *lacZ*) that encodes the enzyme β -galactosidase (lactase). This enzyme will also break down the chemical X-Gal, turning it from a colourless to a blue, indigo-like, compound. Colonies of bacteria that are grown on media containing X-Gal are therefore coloured blue if they carry such as plasmid.

If a new gene is inserted into the plasmid within the *lacZ* gene, lactase is no longer produced and X-Gal is not broken down. Consequently the *E. coli* colonies appear their normal white colour. In this way it is possible to identify those cells that have taken up the plasmid (coloured blue) and those cells that have taken up the modified plasmid (coloured white).

Because incorporating the entire *lacZ* gene could make plasmids too big and difficult to insert into cells, however, usually just small part of the gene (encoding the α -peptide of β -galactosidase) is included in the plasmid — the rest of the *lacZ* gene is carried by the host bacterium's chromosome. Since the plasmid component of the *lacZ* gene complements that found on the chromosome, this technique is called α -complementation.

DH10B carries in its chromosome the lambda-like bacteriophage Φ 80, which includes a partial *lacZ* gene, *lacZ* Δ M15. Coupled with a suitable plasmid, this allows α -complementation and therefore blue/white selection of recombinant colonies as described above.

Δ (*lac*)X74

Deletion of the entire *lac* operon, as well as some flanking DNA. Consequently, the bacterium cannot metabolise lactose (but note that the α -complementation system has been introduced to the strain, as described above).

endA1

This mutation results in the production of an inactive form of endonuclease I. The active form of the enzyme, found on the outside of the *E. coli* cell, digests double-stranded DNA in a non-specific manner. Unsurprisingly, strains with the *endA1* mutation yield plasmids with improved stability, which is useful if one is trying to clone plasmids within a cell so that they can be extracted for research work.

recA1

Numerous *rec* (recombination) genes are found in *E. coli*. The proteins they encode act as a repair mechanism and control recombination of the bacterium's DNA. If present, recombination proteins can rearrange the DNA in a

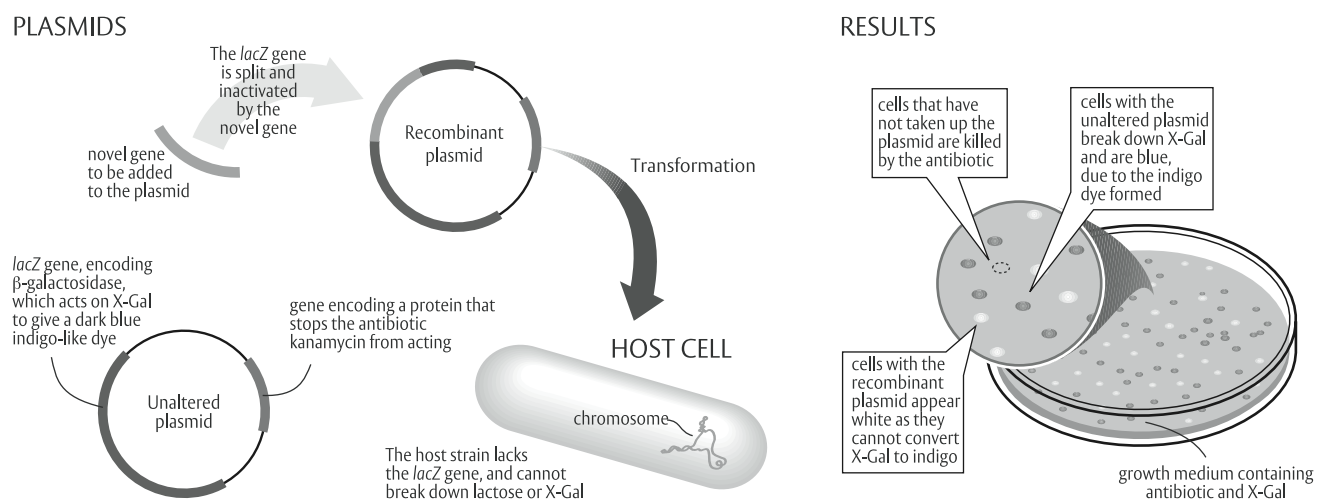

Above: The principle of blue-white selection using the *lacZ* gene and X-Gal. Note: This diagram does not show α -complementation.

plasmid or bacteriophage (such as M13 or lambda) used to genetically modify the bacterium, which would clearly be undesirable. DH10B lacks a *rec* gene central to DNA repair and recombination. As well as preventing the unwanted recombination of DNA, however, this mutation also renders the strain sensitive to ultraviolet light (*e.g.*, from sunlight) and causes the cells to grow more slowly.

relA1

The *relA* gene encodes the RelA protein, which synthesises guanosine tetraphosphate (ppGpp). This highly-phosphorylated nucleotide is a regulator of the so-called *stringent reaction* of bacteria to amino-acid starvation and other stressful conditions (such as a heat shock). This causes the bacteria to divert resources away from growth and division and towards amino acid synthesis until conditions improve. DH10B, in contrast, has the 'relaxed' phenotype: it does not respond in this way to amino acid starvation, consequently it requires all amino acids in the growth medium. This can be exploited to enhance plasmid production, because plasmid replication continues even when cellular growth stops due to amino acid shortage. By limiting the amino acid supply from the growth medium, the amount of plasmid produced per cell can be increased up to tenfold.

deoR⁺

deoR is a regulatory gene (a repressor) that controls the synthesis of deoxyribose, part of the DNA molecule. Until 2008, DH10B was thought to have a mutation in this gene, allowing constitutive (that is, continuous) production of deoxyribose. This was thought to be the reason that the strain had proved to be particularly useful for the replication of large plasmids.

When the strain's genome was sequenced, however, it was found to have the wild type version of the *deoR* gene. Usually, when listing a bacterium's genotype, only the mutations are given — everything else is assumed to be wild type. Because, however, DH10B is often assumed to have a mutant (non-wild type) *deoR*, the superscript '+' is used here to indicate that the strain actually has the wild type allele.

The DeoR protein also acts as a repressor of the *nupG* gene (which is not functional in DH10B — see below).

Δ(*ara*, *leu*)7697

These are two large-scale deletions in DH10B. *ara* is a deletion blocking the utilisation of arabinose and *leu* is a deletion preventing leucine biosynthesis. Therefore the bacteria cannot use arabinose as an alternative energy source to glucose and require leucine to be added to their growth medium.

e14-

The e14 prophage is present in the *E. coli* strain MG1655, from which DH10B is derived, but has been deleted from DH10B.

araD139

This mutation in the gene encoding L-ribulose-phosphate 4-epimerase prevents the bacteria from utilising arabinose.

galE15

galE15 is a point (missense*) mutation in one of the genes encoding an enzyme (UDP-galactose-4-epimerase) involved in galactose metabolism. The mutation results in phenylalanine replacing serine near the enzyme's active site. This change blocks the production of UDP-galactose, resulting in shortened lipopolysaccharides on the outer membrane of the bacterium. The enhanced 'competence' of DH10B is thought to be a result of reduced interference from the membrane lipopolysaccharides in the binding and/or uptake of plasmid DNA.

galU⁺

Wild type gene for this part of the galactose operon.

galK16

A mutation in the gene encoding galactokinase. Therefore this strain cannot metabolise galactose. [*galK16* is an insertion ~170 bp downstream of the *galK* start codon.]

nupG

nupG is one of two nucleoside transport proteins commonly found in *E. coli*. This particular mutation to *nupG* in DH10B is thought to enhance plasmid uptake.

rpsL150 (Str^r)

The S12 protein is a component of the 30S (small) subunit of the bacterial ribosome. *rpsL* is a missense mutation* in the ribosomal protein subunit S12, which confers resistance to streptomycin. [Although phenotypes are not usually listed in the genotype, Str^r, indicating streptomycin resistance, is shown in brackets here for clarity.]

spoT1

The *spoT1* mutation prevents the breakdown of the 'alarm' molecule ppGpp (see *relA1*, above). This is known to enhance the survival of strains that do *not* have the *relA1* mutation, but it is probably of no particular importance in this strain.

λ-

DH10B does not harbour a lambda (λ) bacteriophage.

* a missense mutation is a single nucleotide change in the DNA which results in a different codon, encoding a different amino acid.

References

1. Demerec, M., Adelberg, E.A., Clark, A.J. and Hartman, P.E. (1966) A proposal for a uniform nomenclature in bacterial genetics. *Genetics* **54**, 61–76.
2. Anderson, E. S. (1975) Viability of, and transfer of a plasmid from, *E. coli* K-12 in the human intestine. *Nature* **255**, 502–504.
3. Lederberg, J. (2004) *E. coli* K-12. *Microbiology Today* **31**, 116.
4. Durfee, T. *et al.* (2008) The complete genome sequence of *Escherichia coli* DH10B: insights into the biology of a laboratory workhorse. *Journal of Bacteriology* **190**, 2597–606.

Outline plasmid map

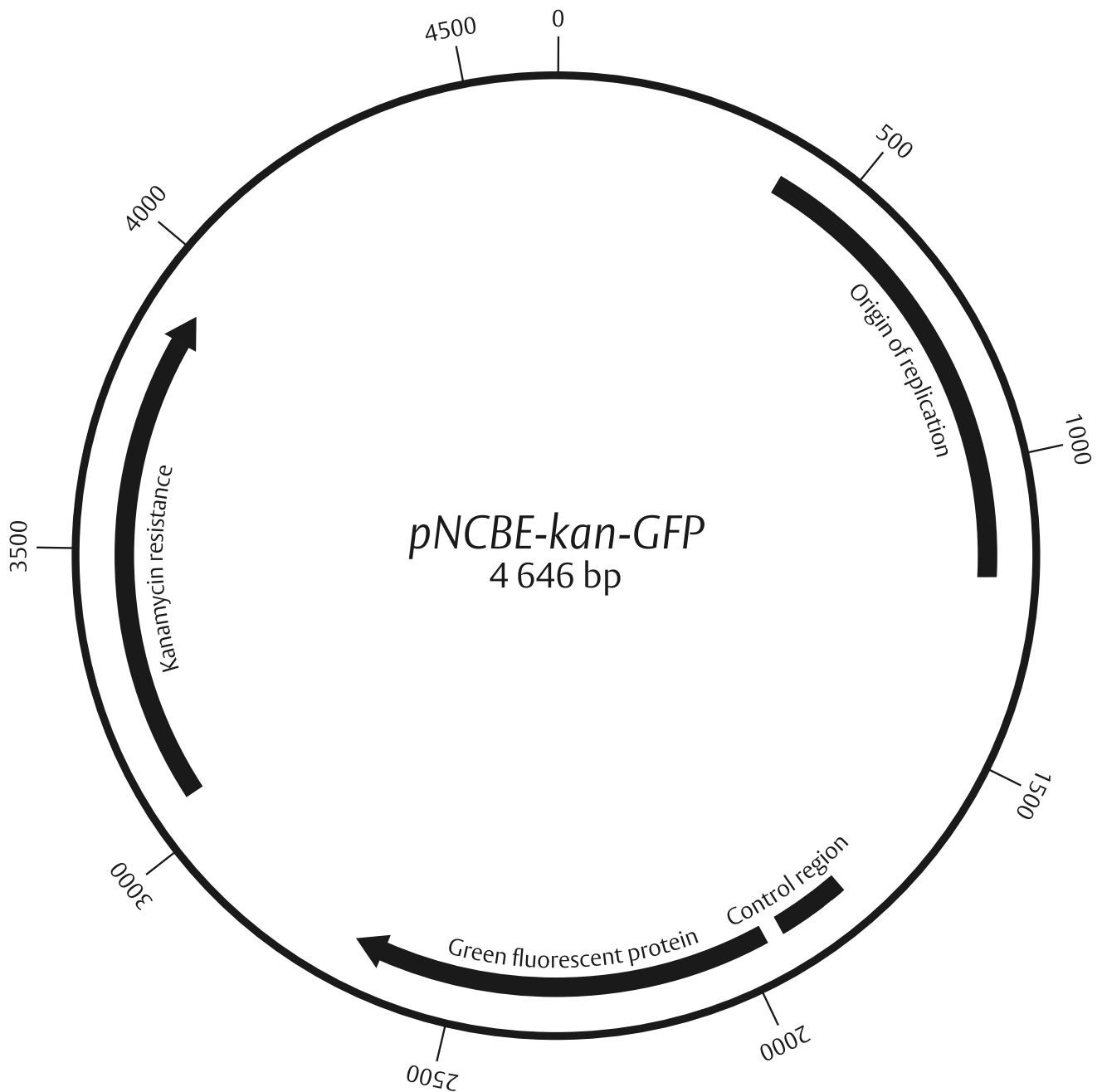

Origin of replication

The origin of replication allows the plasmid to be reproduced within the bacterium, producing between 50 and 700 copies of the plasmid within the cell.

Green fluorescent protein

This gene is derived from the jellyfish *Aequorea victoria*. The green fluorescent protein (GFP) it encodes glows brightly in ultraviolet light.

Control region

This is a 'genetic switch' derived from the *lac* operon which activates transcription of the GFP gene. IPTG in the growth medium mimics the sugar lactose, activating the 'switch'.

Kanamycin resistance

The gene *kan^R* encodes aminoglycoside 3'-phosphotransferase (APH). This enzyme alters the antibiotic kanamycin, preventing it from working.

Safety and genetic modification

Contained Use

All practical work that involves the production or use of genetically-modified organisms (GMOs) is strictly regulated by law throughout the European Union. There are two relevant sets of EU regulations (Directives) governing genetic modification. Laws in the United Kingdom and elsewhere within the EU are enacted to comply with these Directives. One Directive covers 'Contained Use' *e.g.*, work in a laboratory; the other covers 'Deliberate Releases' of GMOs into the environment *e.g.*, field trials of genetically-modified crops.

In general, anyone carrying out work with GMOs must do so only on premises that have been registered with the relevant authority. In England and Wales, this is the Health and Safety Executive (HSE) — or its equivalent in Scotland and Northern Ireland. The organisation, such as a university or research facility, under whose auspices the work is to be done must usually set up a local expert safety committee and procedures to oversee and control the work. These stringent requirements would seem to preclude any work with GMOs in the majority of schools. There is, however, a limited amount of practical work that *can* be done in schools.

'Self-cloning'

The practical procedure described in this kit is known technically as 'self-cloning'. Here, 'cloning' means making copies of DNA within an organism. Originally, the definition of self-cloning was restricted to taking DNA from one species and making copies of it (cloning it) in the *same* species — hence the term *self-cloning*. Later, this definition was widened slightly to include 'marker' genes and control sequences, which might come from other species, provided that these elements had a *long history of safe use* in the organism concerned.

Self-cloning using non-pathogenic microorganisms, such as the strain *E. coli* provided with this kit, is *exempt* from the Contained Use regulations. The bacteria produced *are* covered by the Deliberate Release regulations, however, and it is therefore essential to ensure that an accidental 'release' of the organism into the environment does not occur. This is achieved by physical, chemical and biological containment.

Physical and chemical containment

The genetically-modified microorganisms (GMMOs) must be *physically and chemically contained* by good microbiology laboratory practice, including the destruction of the cultures after use. The relevant basic microbiology laboratory techniques are described on pages 14–16 of this document. These must be followed by those undertaking the work.

Biological containment

The GMMOs are also *biologically contained*, by the selection of a suitable host strain and the careful construction of the plasmid DNA. So, for example, in the current practical procedure, the strain of *E. coli* lacks the ability to pass on the introduced DNA by the natural bacterial 'mating' process of conjugation, and the plasmid DNA is non-methylated so that if it *did* enter a wild-type bacterium, it would be degraded by that organism's own restriction enzymes.

Further details of the genotype of the host strain and the plasmid construction are provided on pages 9–12 of this document.

Alterations to the procedure

It follows from what has been stated above that *no attempt* should be made to alter or add to the procedure described in this kit in a way that might bring those following it outside the umbrella of self-cloning and into the realm of Contained Use. If this was to be done without notifying the relevant authorities and following the other procedures that such work legally requires, users could place themselves and others at risk, and could ultimately be subject to legal action.

Further information

Additional guidance on work with GMOs can be found on the HSE's web site: www.hse.gov.uk/biosafety/gmo/ and in the following publication: *The Genetically Modified Organisms (Contained Use) Regulations 2014*. Health and Safety Executive (2014) The Stationery Office, London. ISBN: 978 0 7176 6641 6. This official document is aimed principally at research scientists, but the latest also mentions work in schools and can be downloaded from the HSE's web site.

Most schools and colleges in the UK will have a copy of *Topics in Safety*, which includes chapters on both microbiology and work with DNA: *Topics in safety* (2001) [Third edition] Association for Science Education. ISBN: 0863573169.

An updated (October 2014) version of Chapter 16, covering work with DNA, can be found on the NCBE's web site: www.ncbe.reading.ac.uk/dnasafety

Practical advice on safety in school science is available to schools that are members in England, Wales and Northern Ireland from CLEAPSS (www.cleapss.org.uk) and in Scotland from SSERC (www.sserc.org.uk).

Video demonstrations of basic microbiology laboratory techniques and other useful information can be found on the Microbiology Society's YouTube channel: www.youtube.com/channel/UCs2_8IXc1SJLvQuGHft_TAA/videos

Good microbiological lab practice

General precautions

- Any exposed cuts and abrasions should be protected with waterproof dressings before the practical work starts.
- There is *no need* to wear disposable gloves, except if a person has skin condition such as eczma or abrasions or cuts to the skin that cannot be covered with waterproof dressings (either because they are too large or awkward to cover or the person concerned is allergic to plasters).
- Everyone involved — teachers, technicians and students should wash their hands *before and after* practical work.
- Laboratory doors and windows should be closed while practical work is in progress. This will reduce air movements and consequently the risk of accidental contamination of plates, *etc.*
- High standards of cleanliness must be maintained. Non-porous work surfaces should be used and they must be swabbed with an appropriate laboratory disinfectant before and after each practical session. (*Virkon*[®] is the disinfectant of choice for school microbiology).
- No hand-to-mouth operations should occur (*e.g.*, chewing pencils, licking labels, mouth pipetting). Eating, drinking and smoking must not be allowed in the laboratory.
- Those carrying out the work should wear laboratory coats and, where necessary, eye protection.

Spills and breakages

Accidents involving cultures should be dealt with as follows:

- Disposable gloves should be worn.
- The broken container and/or spilt culture should be covered with paper towels soaked in disinfectant.
- After not less than 10 minutes, it must be cleared away using paper towels and a dustpan.
- The contaminated material must be submerged in a suitable disinfectant for 24 hours or placed in a microbiological disposal bag.
- The contaminated material must then be autoclaved before disposal. The dustpan should also be autoclaved or placed in a bucket of suitable disinfectant solution (*e.g.*, *Virkon*[®]) for 24 hours.
- Contaminated paper towels should be autoclaved.

Contamination of skin or clothing

As soon as possible, anyone affected should wash with antibacterial soap. Severely contaminated clothing should be placed in disinfectant before it is laundered.



Sources of microbes

All micro-organisms should be regarded as potentially harmful. However, the strain of *E. coli* used in this kit presents minimum risk given good microbiology laboratory practice. Other species of bacteria *must not* be used for this work, as this might contravene the regulations governing genetic modification (see page 13).

In general, stock slope cultures of bacteria should be kept in the dark at room temperature, not in a fridge. Slope cultures should be subcultured onto fresh nutrient agar every six weeks or so. You should not attempt to maintain the culture for an extended period, however, as mutations can occur in the storage conditions that are found in schools, and these may lead to the failure of the practical work. Cultures may also become contaminated with repeated sub-culturing. If in doubt, obtain a fresh culture.

Aseptic techniques

The aims of aseptic techniques are:

- To obtain and maintain pure cultures of microorganisms;
- To make working with microorganisms safer.

A 'pure culture' contains only one species of microorganism, whereas a 'mixed culture' contains two or more species.

Contamination of cultures is always a threat because microbes are found everywhere; on the skin, in the air, and on inanimate objects. To obtain a pure culture, sterile growth media and equipment must be used and contaminants must be excluded. These are the main principles of aseptic techniques.

It is unrealistic to expect inexperienced school students to be fully accomplished at aseptic techniques. Sterile, disposable items are therefore provided in this kit, so that the necessary procedures can be carried out as easily and safely as possible.

Growth media must be prepared as described on page 5 of this booklet. Sterile Petri dishes should be used. Lids must be kept on containers to prevent contamination.

Practical work should be carried out near a Bunsen burner flame. Rising air currents from the flame will carry away any microbes that could contaminate growth media and pure cultures.

When cultures are transferred, tops and lids of containers should not be removed for longer than necessary. After a lid has been taken from a bottle, it should be kept in the hand until it is put back on the bottle. This prevents contamination of the bench and the culture. After removal of the top, the neck of the culture bottle should be flamed briefly for 1–2 seconds. This will kill any microbes present there and produce convection currents which will help to prevent accidental contamination of the culture.

With practice, it is possible to hold a bottle containing the microbes in one hand and the loop or pipette in the other in such a way that the little finger is free to grip the bottle top against the lower part of the hand. (In this case, it is important that the bottle top should be loosened slightly before the inoculation loop is picked up.)

Obviously, unlike glassware, the sterile plastic spreaders, loops, microcentrifuge tubes and pipettes that are provided in this kit must *not* be flamed.

If, however, you use wire loops (e.g., as replacements for the disposable loops in this kit) they should be heated until they are red hot along the entire length of the wire part. This should be done both before and after transfer of cultures takes place. Loops should be introduced slowly into the Bunsen burner flame to reduce sputtering and aerosol formation.

When the Bunsen is not in use it should be kept on the yellow flame, so that it can be seen. A blue flame about 5 cm high should be used for sterilising loops and flaming the necks of bottles.

Avoid contaminating the work area. Any non-disposable instruments should be sterilised immediately after use and used plastic pipettes, tubes and other plastic items should be placed directly into a jar of fresh disinfectant (*Virkon*[®]) solution, so that they are completely immersed.

Incubation of cultures

Label the Petri dish around the edge of the base. A student's name, date and the name of the organism used will allow the plate and its contents to be identified.

Use self-adhesive tape to seal Petri dishes at a few places around the rim. The seal will ensure that the plates are not accidentally opened or tampered with. Do not seal plates completely as this could create anaerobic growth conditions within the dish.

Bacterial cultures in Petri dishes should be incubated with the base uppermost, so that any condensation that forms falls into the lid and not onto the colonies.

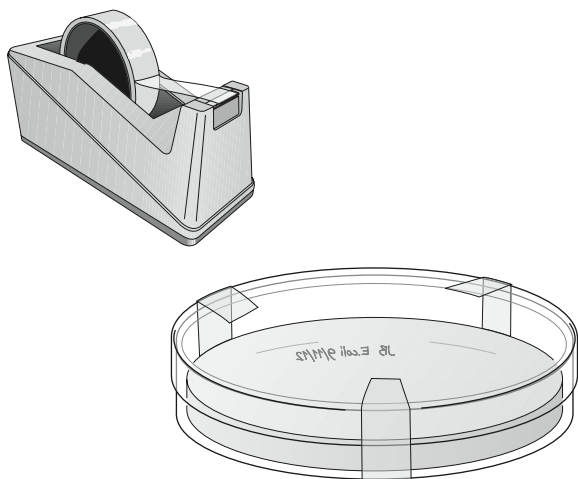

Incubation at 37 °C

Although in general, 30 °C is regarded as the upper limit for the incubation of microbial cultures in UK schools, the delicate strains of *E. coli* used for cloning work often require incubation at 37 °C. Good microbiological practice, coupled with the use of selective growth media will ensure that contaminating human pathogens are not inadvertently cultivated at this temperature. Official safety guidelines for school microbiology from the Association for Science Education, CLEAPSS, SSERC and others in the UK allow for this possibility.

Disposal

It is very important to dispose of all the materials used in a practical class properly, especially any item that has been in contact with cultures of bacteria. All non-disposable containers used for storing and growing cultures must be autoclaved, then washed and rinsed as necessary, before re-use.

There should be a discard jar of fresh disinfectant (*Virkon*[®]) near each work area. Disposable plastic pipettes, loops, spreaders, tubes and any liquid from cultures should be put into the disinfectant pot immediately after use. After soaking for 24 hours, these materials should be autoclaved then disposed of in the normal waste.

Contaminated paper towels, cloths and plastic Petri dishes should be put into an autoclave bag and sterilised by autoclaving before placing in the normal waste.

Glassware that is not contaminated (e.g., flasks used for making up media) can be washed normally. Broken glassware should be put in a waste bin reserved exclusively for that purpose. If any glassware is contaminated it must be autoclaved before disposal. Uncontaminated broken glassware can be thrown away immediately.

Autoclaving

Sterilisation is the complete destruction of all microorganisms, including their spores.

All equipment should be sterilised before starting practical work so that there are no contaminants. Cultures and contaminated material should also be sterilised after use for safe disposal.

Autoclaving is the preferred method of sterilisation for culture media, aqueous solutions and discarded cultures. To comply with the regulations governing genetic modification, it is *essential* that any genetically-modified microorganisms are killed before disposal. Autoclaving is the most reliable method of achieving this.

The process uses high pressure steam, usually at 121 °C. Microbes are more readily killed by moist heat than dry heat as the steam denatures their proteins. Domestic pressure cookers can be used in school laboratories instead of autoclaves, but their small capacity can be a disadvantage when dealing with class sets of material.

Principles of autoclaving

Two factors are critical to the effectiveness of autoclaving. Firstly, all air must be removed from the autoclave. This ensures that high temperature steam comes into contact with the surfaces to be sterilised: if air is present the temperature at the same steam pressure will be lower.

The materials to be sterilised should be packed loosely so that the air can be driven off. Screw-capped bottles and jars should have their lids loosened slightly to allow air to escape and to prevent a dangerous build-up of pressure inside them.

Secondly, enough time must be given for heat to penetrate (by conduction) to the centre of media in Petri dishes or other containers. The times for which media or apparatus must be held at various temperatures for sterilisation are shown in the graph and table below.

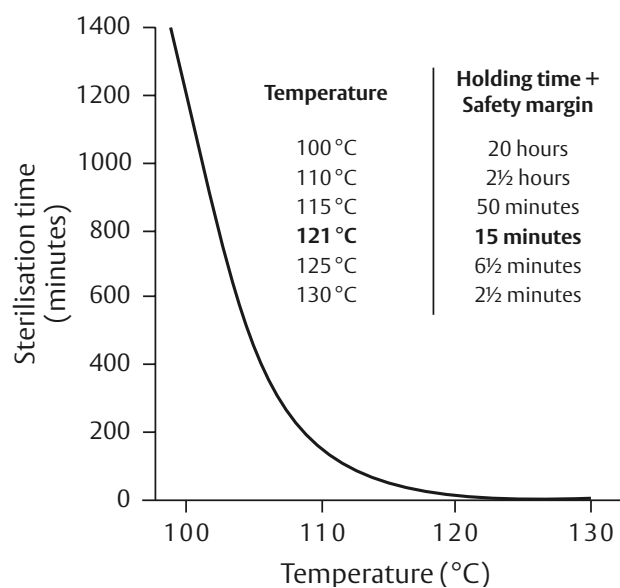

Notice that just a small difference in temperature can result in a significant difference in the time required for sterilisation. It is also important that these temperatures are reached by *all* of the materials to be sterilised for the specified time *e.g.*, the broth in the very centre of a flask.

Three factors contribute towards the duration of the autoclaving process:

- **penetration time** — the time taken for the centre-most part of the autoclave's contents to reach the required temperature;
- **holding time** — the minimum time in which, at a given temperature, all living organisms will be killed;
- **safety time** — half the holding time, included as a safety margin.

Domestic pressure cookers operate at 121°C. Thus the total sterilisation time might typically be: a penetration time of 5 minutes plus 15 minutes holding time (including a safety margin) — giving a total time of 20 minutes.

The effectiveness of an autoclave can be checked by using autoclave test strips (available from laboratory suppliers) which change colour if the process has worked properly (autoclave tape does not show this).

Use and care of autoclaves

The manufacturer's instructions should always be followed when using a pressure cooker or an autoclave. Particular care should be taken to ensure that there is enough water in the autoclave so that it does not boil dry during operation. Most domestic pressure cookers require at least 250 mL of water — larger autoclaves may need far greater volumes.

The use of distilled or deionised water in the autoclave will prevent the build-up of limescale. Autoclaves should be dried carefully before storage to prevent corrosion of the pressure vessel.

When the autoclave is used, before the exit valve is tightened, steam should be allowed to flow freely from the autoclave for about one minute to drive off all the air inside. After the autoclave cycle is complete, sufficient time must be allowed for the contents to cool and return to normal atmospheric pressure. The vessel or valves should not be opened whilst under pressure as this may cause scalding.

Premature release of the lid and the subsequent reduction in pressure will cause any liquid inside the autoclave to boil and spill from vessels.

Chemical sterilisation

Historically, many different chemicals have been used in microbiology to sterilise used equipment and work surfaces. Hypochlorites (such as bleaches) and clear phenolics should no longer be used, however. *Virkon*[®] can be safely used for most microbiology laboratory purposes. The solution remains pink while active, but if it turns colourless or pale, it is no longer effective and should be disposed of.

The manufacturer's and supplier's instructions should always be followed with care. **IMPORTANT: Eye protection must be worn when handling concentrated solutions of disinfectant.**

Handling disposable sterile items

The plastic pipettes, loops, tubes and spreaders provided in this kit are sterile. Remind students that the packets should be opened with care to ensure that the tips of pipettes, loops and so on are not touched.

These items should all be placed in a discard container of disinfectant after use, where they should be left for 24 hours before autoclaving and disposal in the normal waste.

Sterilising microcentrifuge tubes

If necessary, microcentrifuge tubes can be sterilised by autoclaving before use — they will not melt. Place them in a glass beaker, cover it with aluminium foil and autoclave at 121 °C for 15 minutes.

After use, microcentrifuge tubes should be placed, open, in disinfectant solution, left for 24 hours, then autoclaved before disposal in the normal waste.

Further investigations

Although for safety reasons, there is a limit to the scope of extensions to this practical work that can be attempted in schools, there are several variations on the technique described in the Student's guide to this kit which can be carried out. For example, students could investigate the effect of changing one or more of the following conditions:

- the age of the host cells used;
- the mass of plasmid DNA used;
- the concentration of kanamycin in the medium (note that the 'undiluted' kanamycin agar contains 50 mg of kanamycin per mL of medium);
- the duration of the recovery period;
- the temperature of the recovery period.

Because of the nature of the kanamycin resistance (see pages 7–8) changing the duration of the recovery period

will change the transformation efficiency dramatically. A recovery period of two hours, for example, will produce many more bacterial colonies than a 15-minute period.

Transformation efficiency is expressed as the number of transformed bacterial colonies produced per microgram (μg) of plasmid DNA. The worksheet on the following page guides students through the necessary calculation.

Some of these investigations could be attempted as whole class exercises. For example, if different students or groups in the class are each provided with a different concentration of plasmid DNA, graphs of DNA mass vs the number of colonies, and DNA mass vs the transformation efficiency can be plotted.

Such graphs can be used to determine the point at which the transformation reaction is saturated (the point at which increasing the concentration of plasmid no longer results in greater transformation efficiency).

Infrequently asked questions

Why can't you use GFP for selection?

Bacteria transformed by the *pNCBE-kan-GFP* plasmid glow green in ultraviolet light due to the green fluorescent protein produced by the cells. Students sometimes ask why GFP alone can't be used to identify the transformed cells (in other words, why do you need the antibiotic?).

Individual cells that carry antibiotic resistance plasmids are normally disadvantaged compared to their neighbours without them, but in the presence of appropriate antibiotics, such plasmid-bearing cells thrive while their less well-endowed neighbours perish. In this way, selection pressure is applied to maintain the plasmid in the population of cells.

Without that pressure, the few transformed cells would be swamped by their untransformed neighbours, and the plates would be covered by a uniform 'lawn' of ordinary *E. coli* cells rather than individual green fluorescent colonies.

Why does the jellyfish make GFP?

No one knows why the jellyfish *Aequorea victoria* makes GFP. Several misleading photographs, particularly in promotional literature for educational kits, show the jellyfish glowing bright green over its entire surface. In reality, the GFP is made only in small spots around the rim of the jellyfish where it is co-expressed with a luminous protein, aequorin. (Remember, GFP does not fluoresce except when illuminated: it is not luminous, and does not glow in the dark.)

Some of the light from the luminous aequorin is absorbed by the GFP, causing it to fluoresce a blue-green colour. Nobel Laureate Roger Tsien has suggested that the colour of the bioluminescence may vary with depth, due to pressure changes altering the structure of the GFP. This hypothesis has yet to be tested, however.

Acknowledgements

The *pNCBE-kan-GFP* plasmid and the practical protocol were developed by Jarek Bryk at the National Centre for Biotechnology Education (NCBE), University of Reading. This procedure is a simplified version of an undergraduate

practical that Jarek developed with funding from the European Commission through a Marie Curie Fellowship.

This booklet and the accompanying Student's guide were written and illustrated by Dean Madden at the NCBE.

Transformation efficiency

How good were you at transforming bacteria?

You can work this out by calculating the *transformation efficiency*.

This is expressed as the number of transformed colonies produced per microgram (μg) of plasmid DNA.

1. Count the number of transformed colonies on your plate.

Number of colonies = _____

2. Calculate the mass, in micrograms (μg), of plasmid DNA used.

(There were 0.5 micrograms (μg) of plasmid DNA in the 198 μL of solution you were given.)

Mass of plasmid DNA used = _____

3. Calculate the volume of bacterial cell suspension you spread on your plate.

(One drop from the pipette you were given = 33 μL)

Volume of suspension spread on plate = _____

4. Calculate the fraction of the cell suspension you spread on your plate (volume of suspension spread [3] \div total volume of suspension (198 μL)).

Fraction of suspension spread on plate = _____

5. Calculate the mass of plasmid DNA (in μg) contained in the cell suspension you spread on the plate (total mass of plasmid [2] \times fraction spread [4]).

Mass of plasmid DNA spread on plate = _____

6. Calculate the transformation efficiency (number of colonies [1] \div mass of plasmid spread [5]).

Transformation efficiency = _____

Units of measurement

Mass

1 gram (g) = 1 000 milligrams (mg)

1 milligram (mg) = 1 000 micrograms (μg)

1 microgram (μg) = 1 000 nanograms (ng)

Volume

1 litre (L) = 1 000 millilitres (mL)

1 millilitre (mL) = 1 000 microlitres (μL)

Note

Some people prefer to use the cubic decimetre (dm^3), cubic centimetre (cm^3) and cubic millimetre (mm^3) in preference to the litre, millilitre and microlitre, as S.I. units for volume are derived from those for length. In practice, almost no scientists, scientific journals or instruments use these units. To avoid possible confusion, an upper-case 'L' for litre has been used here.

Thinking about ‘controls’

1. What would you expect to see on the following plates and why?

- a. Bacteria to which plasmid DNA had *not* been added, that were plated on LB agar containing antibiotic and IPTG.

- b. Bacteria to which plasmid DNA had been added, that were plated on LB agar containing antibiotic but no IPTG.

- c. Bacteria to which plasmid DNA had been added, that were plated on LB agar containing IPTG but no antibiotic.

2. Describe the experiments that would you need to carry out to test whether the antibiotic kanamycin makes transformed bacteria glow in UV light.

The protocol in words

This can be used in conjunction with the Student's guide

It can be used as a sequencing exercise, where students are given the sentences below in a random order, and have to place them in the correct sequence with the aid of the pictures in the Student's guide.

Put on a lab coat.

Place the contaminated pipette and open tube of bacteria into the disinfectant.

Wash your hands with antibacterial soap.

Use a sterile spreader to coat the surface of the agar with the bacterial suspension. Rotate the plate as you do this, so that the culture is spread evenly over the plate.

Wipe down the work surface using disinfectant solution and paper towels.

Place the contaminated spreader in the disinfectant.

Set out the work area with everything you need, including a container of disinfectant solution for contaminated waste and a Bunsen burner with a yellow flame.

Seal the Petri dish with adhesive tape.

Leave the plate to dry for ~30 minutes.

Use a sterile loop to scrape a visible mass of bacteria from the stock plate (but don't dig into the agar).

Turn your plate over and write your name, the date and the bacteria used on the edge of the base of the Petri dish.

Put the loop of bacteria into the ice-cold plasmid DNA solution and rotate it vigorously to dislodge the bacteria and suspend them in the solution. Hold the tube almost horizontally as you do this.

Place the Petri dish, inverted (agar uppermost) in an incubator at 37 °C.

Clean the work area with disinfectant.

Place the contaminated loop in the disinfectant solution.

Wash your hands with antibacterial soap.

Close the lid tightly and flick the tube for 1-2 minutes to make sure you have a uniform suspension of bacteria. Now incubate the tube on ice for 15 minutes. This allows the bacteria to take up the plasmid DNA.

After about 24 hours, examine the bacteria under ultraviolet light.

Use a sterile pipette to place 3 drops of bacterial suspension onto the centre of a Petri dish of agar.

Dispose of all contaminated materials and cultures by autoclaving them.